

Solmaz Maxi

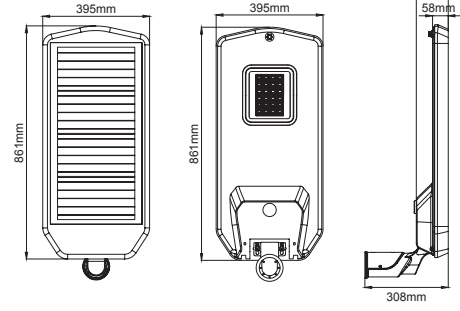

Sensor integrated to luminaire connected to the controller enables further saving on the stored electricity at Li-Fe battery.

Armatür gövdesine entegreli kontrol ünitesine bağlı sensör sayesinde Li-Fe batarya içerisine depolanan elektrik daha tasarruflu kullanılır.

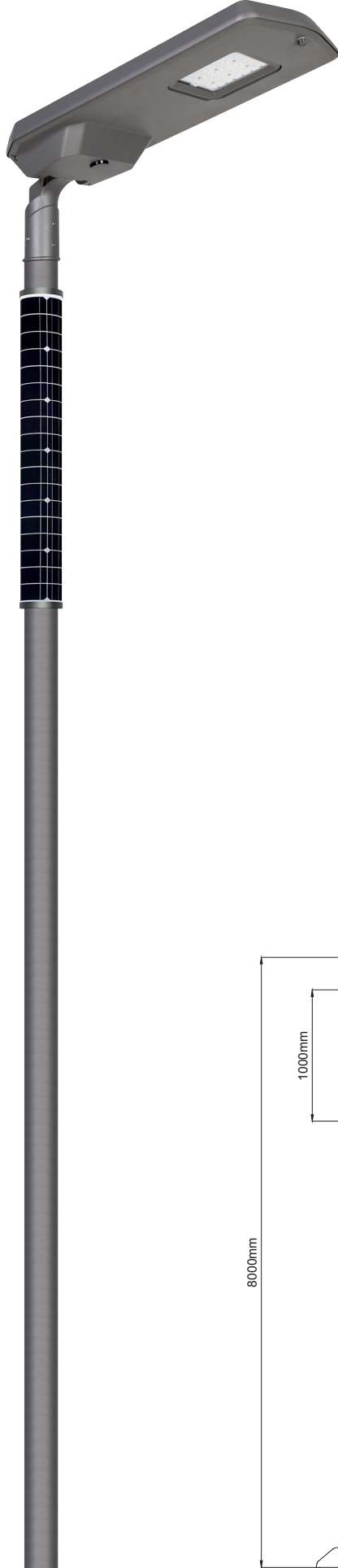

MonoCrystal solar panel integrated to luminaire housing with silicon seal to ensure IP protection.

Monokristal solar panel armatür gövdesine silikon conta sistemi ile entegre edilerek IP koruması sağlanır.

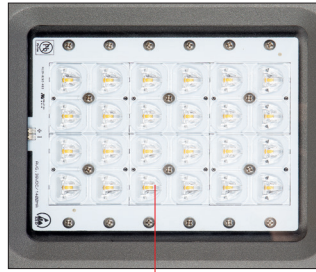

High efficient LED and LENS optics integrated to enable maximum efficiency.

Yüksek verimli LED ve LENS optik birbirine entegre edilerek üst düzey verimlilik sağlanır.



Luminaire adjustable in vertical direction from bracket.

Armatür braketten dikey ekseninde hareket ettirilebilir.

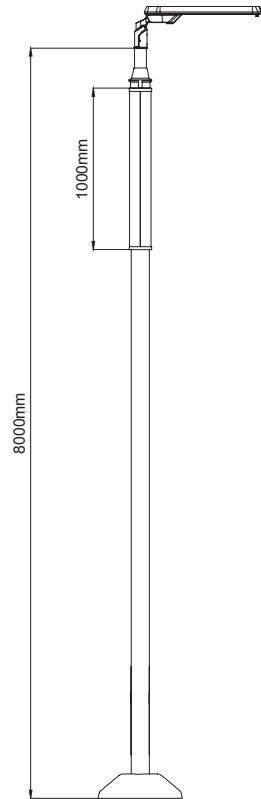

Solmaz Maxi

Solmaz Maxi / 007.ST.26351

System Power / Sistem Gücü		50W
Lumen Output from Fixture / Armatür Çıkış Lümeni CRI>80	4000K	7778lm
Max. Pole Distance / Max. Direk Açıklığı (a)		42m
Max. Pole Height / Max. Direk Yüksekliği (h)		8m
Max. Road Width / Max. Yol Genişliği (L)		6m
Lighting Class / Aydınlatma Sınıfı		P2

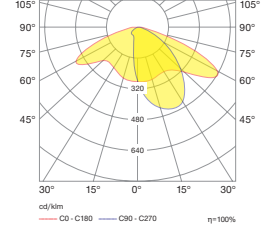
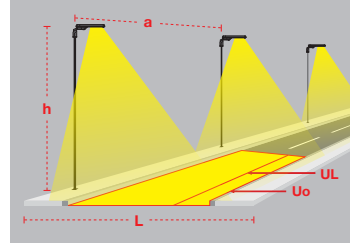

Product Data / Armatür Data	
Item No / Ürün Kod	O07.ST.26351.50.840.05
Family Name / Aile Adı	Solmaz Maxi
Material / Malzeme	Die-Cast Aluminium / Alüminyum Enjeksiyon
Lifetime LED / LED Ömrü	L70 / B50 50000 h
Optic / Optik	Asymmetric Streetlight LENS / Asimetrik Sokak Aydınlatma Lensi
PV Panel Power / PV Panel Gücü	110W
Panel Type / Panel Tipi	MonoCrystal
Solar Panel Voltage / Solar Panel Voltajı	18V
PV Panel Efficiency / PV Panel Verimi	21%
Luminaire Power / Armatür Gücü	50W
Led Panel Voltage / Led Panel Voltajı	44V
Number of LEDs / Led Sayısı	32 Pcs / 32 Adet
PCB / Devre	2P16S
LED Type / Led Tipi	3535
Lumen / Lümen	8000lm
Luminaire Efficiency / Armatür Verim	160lm/W
CRI	70
Battery Power / Batarya Gücü	460W
Battery Voltage / Batarya Voltajı	12,8V
Battery Current / Batarya Akımı	36A
Battery Type / Batarya Tipi	LiFePO4
Battery Lifetime / Batarya Ömrü	3000
Controller / Kontrolcü Tipi	MPPT
Operating Hours without Sunshine / Bulutlu Gün Çalışma Süresi	45 hours / 45 saat
Ambient Working Temperature / Çalışma Sıcaklığı	-20°C / +50°C
Protection Rating / Koruma	IP66

Advised Pole Heights for Solmaz Maxi Solar with advised anchorage lengths / Solmaz Maxi Solar için tavsiye edilen direk ve ankraj yükseklikleri

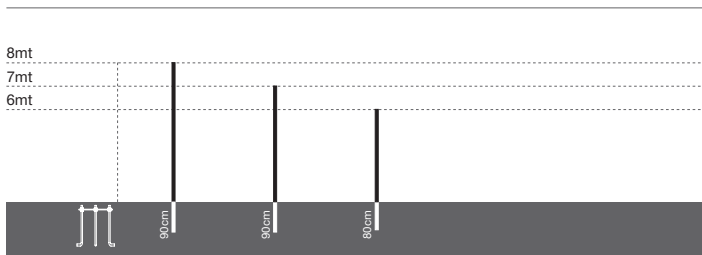

Lithium-ion Lithium-ion based battery packs have the added advantage that they have a higher power density than lead, which means they have more available power for the same mass of a lead battery. This advantage, combined with the longer life expectancy and higher rate of depth of discharge (DOD), offering an attractive option for solar lighting applications, resulting in a longer lifetime. All Lithium-ion energy storage packs have an integrated Battery Management System (BMS) which monitors the health, charging and discharging of the energy storage pack. This safeguards the cells so that they are not over charged or discharged, maximising their lifetime. Battery pack operating temperature: -20°C to +60°C. We can offer to our customers both option either to place the battery inside ground or inside pole.

Lityum-ion batarya teknolojisi ile daha küçük boyutta piller ile daha yüksek enerji elde edilebiliyor. Bu teknoloji solar aydınlatma armatürlerinde daha uzun ömür ve lümen çıkışı sağlamakta. Tüm Lityum-ion enerji depolama ünitelerinde Batarya Kontrol Sistemi (BMS) sistemi bulunmakta olup, bataryaların ömrünü ve çalışma verimini gözlemlene imkanı sunmakta olup fazla veya az şarj olma veya enerjinin boşalması gibi sorunların önüne geçilmektedir. Batarya -20° ile +60° sıcaklıklarında çalışabilmektedir. Müşterilerimize bataryayı ister toprak altına, ister direk içine saklama imkanı sunabiliyoruz.