

Fener

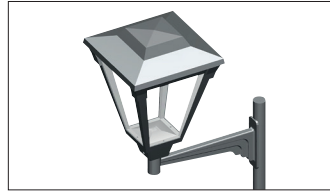
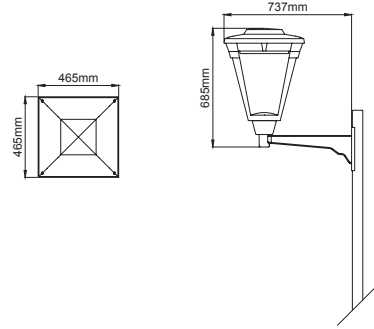
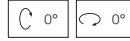

Application Notice / Uygulama Notu

Fener is mainly suitable for installation in medium traffic streets and pedestrian roads. High efficient optical structure enables up to 20mt pole spacing in a 6mt width standart street.

Fener orta trafik yoğunluğuna sahip cadde ve yaya yollarında tercih edilmektedir. Yüksek verimli optik yapısı sayesinde standart 6mt genişliğe sahip yollarda 20m'tye kadar direk aralığını mümkün kılar.

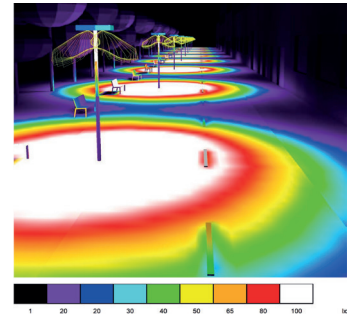

Ordering Code Example / Sipariş Kodu Örneği



* Code example / Kod örneği:

O07.ST.07975 . 60 . 740 . 05

1 2 3 4

- 1- Product code / Armatür kodu
- 2- Power / Güç
- 3- CRI / Kelvin
- 4- Colour / Ürün renk

Fener / O07.ST.07975

System Power / Sistem Gücü		40W
Lumen Output from Fixture / Armatür Çıkış Lümeni CRI>70	4000K	5400lm
Driving Current / Sürüş Akımı		265mA
Pole Distance / Direk Açıklığı (a)		16m
Pole Height / Direk Yüksekliği (h)		4m
Road Width / Yol Genişliği (L)		6m
Lighting Class / Aydınlatma Sınıfı		-
Optic Type / Optik Tipi : Maximizing pole distance / Maksimum direk aralığı		

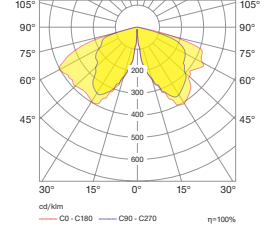
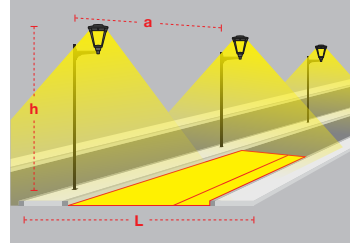

Fener / O07.ST.07975

System Power / Sistem Gücü		60W
Lumen Output from Fixture / Armatür Çıkış Lümeni CRI>70	4000K	7860lm
Driving Current / Sürüş Akımı		400mA
Pole Distance / Direk Açıklığı (a)		20m
Pole Height / Direk Yüksekliği (h)		6m
Road Width / Yol Genişliği (L)		6m
Lighting Class / Aydınlatma Sınıfı		-
Optic Type / Optik Tipi : Maximizing pole distance / Maksimum direk aralığı		

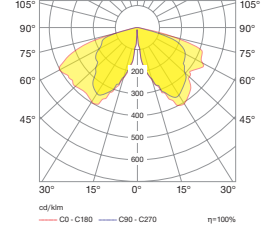
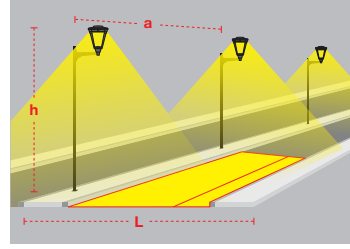

Product Data / Armatür Data	
Item No / Ürün Kod	O07.ST.07975.60.740.05
Family Name / Aile Adı	Fener
Material / Malzeme	Die-Cast Aluminium / Alüminyum Enjeksiyon
Lifetime LED / LED Ömrü	L70 / B50 50000 h
Optic / Optik	Asymmetric Streetlight LENS / Asimetrik Sokak Aydınlatma Lensi
Luminaire Maximum Power / Armatür Maksimum Güç	60W
Number of LEDs / Led Sayısı	48
PCB / Devre	24S2P
LED Type / Led Tipi	3535
CRI	70
Ambient Working Temperature / Çalışma Sıcaklığı	-20°C / +50°C
Protection Rating / Koruma	IP66

EN

- Street lighting system for use with LEDs.
- Corrosion resistant die-cast aluminium body.
- Silicon gasket.
- All exterior parts are stainless steel.
- Tempered safety glass.
- Optionally 10KV surge protector can be integrated.
- Mains voltage: 220-240V / 50-60Hz.
- Clever thermal design.
- High visual comfort.
- Colour tolerance max. 3 SDCM.
- Recommended mounting height 4-6mt depending on wattage selection.
- Pole-top installation on poles with ending part from Ø42 to Ø63mm.
- High efficiency up to 135lm/W.
- Astro dim option available upon request.
- Motion sensor can be integrated optionally.
- Apart from standart 4000K, 2700K, 3000K, 3500K, 5000K and 6500K CCT options are also available.

TR

- LED'li sokak aydınlatma armatürü.
- Korozyona dayanıklı alüminyum enjeksiyon gövde.
- Silikon contalı.
- Dışarda kalan tüm metal parçalar paslanmaz çelikten.
- Tamperli cam.
- 10KV gücünde gerilim koruyucu entegre edilebilir.
- 220-240V / 50-60Hz enerji girişi.
- Akıllı soğutma tasarımı.
- Yüksek aydınlatma konforu.
- Renk toleransı max. 3 SDCM.
- Watt seçimine göre 4-6mt direk yüksekliklerinde kullanıma uygundur.
- Konsol iç çapı Ø42 - Ø63mm arası uyumludur.
- 135lm/W'a kadar ulaşan verimli yapı.
- Astro dim seçeneği mevcuttur.
- Alternatif olarak hareket sensörü entegre edilebilir.
- Standart 4000K ışık renginin yanında alternatif olarak 2700K, 3000K, 3500K, 5000K ve 6500K seçenekleri de mevcuttur.