

Quasar Mega

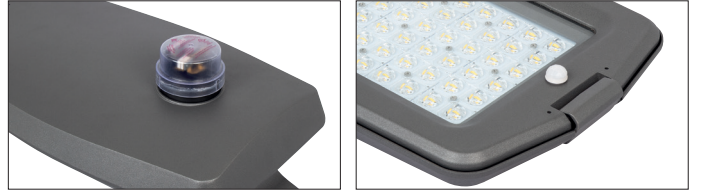

Ordering Code Example / Sipariş Kodu Örneği

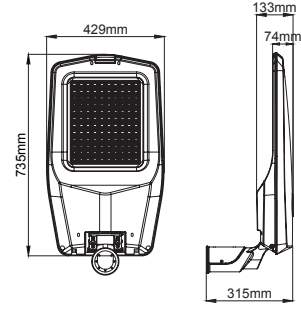
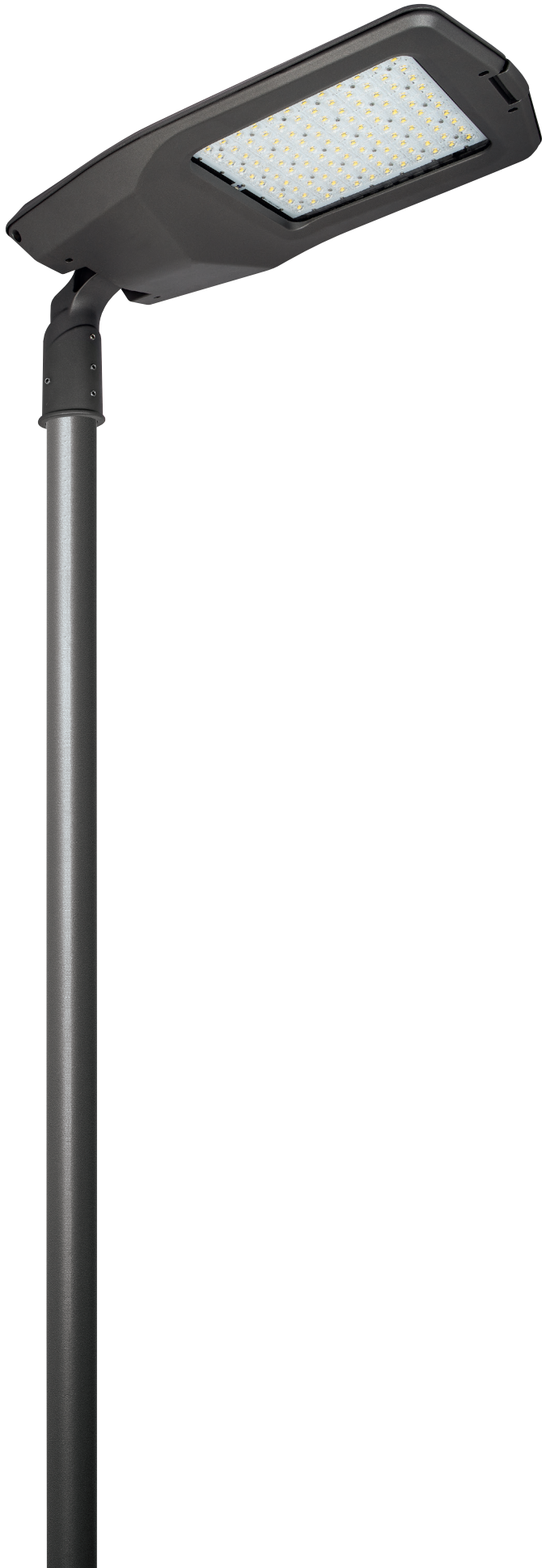

* Code example / Kod örneği:

007.ST.16315 .200. 740 . 05

1 2 3 4

- 1- Product code / Armatür kodu
- 2- Power / Güç
- 3- CRI / Kelvin
- 4- Colour / Ürün renk

Quasar Mega

Quasar Mega / O07.ST.16315

System Power / Sistem Gücü		175W
Lumen Output from Fixture / Armatür Çıkış Lümeni CRI>70	4000K	23998lm
Driving Current / Sürüş Akımı		500mA
Pole Distance / Direk Açıklığı (a)		47m
Pole Height / Direk Yüksekliği (h)		12m
Road Width / Yol Genişliği (L)		10.5m
Lighting Class / Aydınlatma Sınıfı		M3
Optic Type / Optik Tipi : Maximizing pole distance / Maksimum direk aralığı		

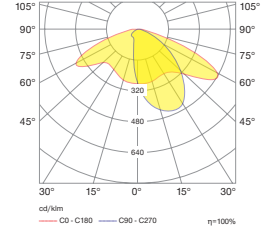
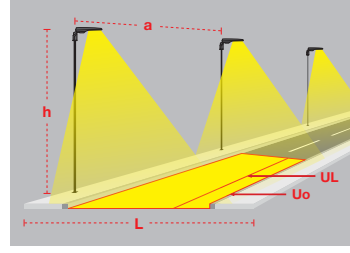

Quasar Mega / O07.ST.16315

System Power / Sistem Gücü		200W
Lumen Output from Fixture / Armatür Çıkış Lümeni CRI>70	4000K	26303lm
Driving Current / Sürüş Akımı		575mA
Pole Distance / Direk Açıklığı (a)		47m
Pole Height / Direk Yüksekliği (h)		12m
Road Width / Yol Genişliği (L)		10.5m
Lighting Class / Aydınlatma Sınıfı		M2
Optic Type / Optik Tipi : Maximizing pole distance / Maksimum direk aralığı		

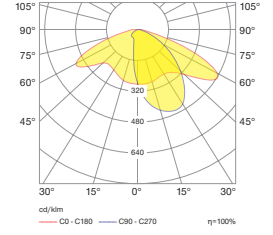
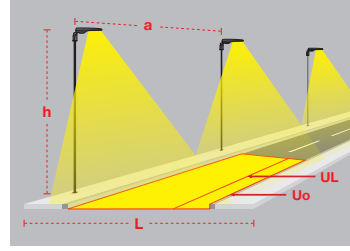

Product Data / Armatür Data	
Item No / Ürün Kod	O07.ST.16315.200.740.05
Family Name / Aile Adı	Quasar Mega
Material / Malzeme	Die-Cast Aluminium / Alüminyum Enjeksiyon
Lifetime LED / LED Ömrü	L70 / B50 50000 h
Optic / Optik	Asymmetric Streetlight LENS / Asimetrik Sokak Aydınlatma Lensi
Luminaire Maximum Power / Armatür Maksimum Güç	200W
Number of LEDs / Led Sayısı	120
PCB / Devre	24S2P
LED Type / Led Tipi	3535
CRI	70
Ambient Working Temperature / Çalışma Sıcaklığı	-20°C / +50°C
Protection Rating / Koruma	IP66

EN

- Street lighting system for use with LEDs.
- Silicon gasket.
- All exterior parts are stainless steel.
- Tempered safety glass.
- Optionally 10KV surge protector can be integrated.
- Mains voltage: 220-240V / 50-60Hz.
- Clever thermal design.
- High visual comfort.
- Colour tolerance max. 3 SDCM.
- Recommended mounting height maximum 12mt.
- Convenient to be used in M2 and M3 road standards.
- High performance optics suitable for streetlighting standards.
- Replaceable driver unit and control gear with no tool requirement.
- Pole-top installation on poles with ending part from Ø53 to Ø74mm.
- Driving current options of 500mA and 575mA.
- 1-10V, DALI and Astro dim options available upon request.
- Smart lighting control systems can be integrated.
- Motion sensor can be integrated optionally.
- Apart from standart 4000K, 2700K, 3000K, 3500K, 5000K and 6500K CCT options are also available.

TR

- LED'li sokak aydınlatma armatürü.
- Silikon contalı.
- Dışarda kalan tüm metal parçalar paslanmaz çelikten.
- Tamperli cam.
- 10KV gücünde gerilim koruyucu entegre edilebilir.
- 220-240V / 50-60Hz enerji girişi.
- Akıllı soğutma tasarımı.
- Yüksek aydınlatma konforu.
- Renk toleransı max. 3 SDCM.
- 12mt direk yüksekliğine kadar kullanıma uygundur.
- M2 ve M3 yol standartlarında kullanıma uygundur.
- Sokak aydınlatma standartlarına uygun verimli optik yapı.
- Ekipman gerekmeden trafo ünitesine müdahale edilebilir.
- Konsol iç çapı Ø53 - Ø74mm arası uyumludur.
- 500mA ve 575mA sürüş akımlarına uyumlu.
- 1-10V, DALI ve Astro dim seçenekleri mevcuttur.
- Akıllı sokak aydınlatma kontrol sistemi uygulanabilir.
- Alternatif olarak hareket sensörü entegre edilebilir.
- Standart 4000K ışık renginin yanında alternatif olarak 2700K, 3000K, 3500K, 5000K ve 6500K seçenekleri de mevcuttur.