

Sivo Super Slim Ring

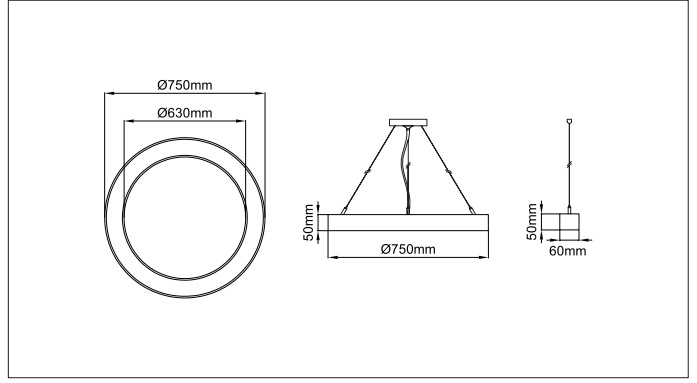

* Code example / Kod örneği:

102.LL.14105.075.050.830.01

- 1- Product code / Armatür kodu
- 2- Diameter / Çap
- 3- Power / Güç
- 4- CRI / Kelvin
- 5- Colour / Ürün renk
- 6- Control type / Kontrol tipi

5 / Product Color / Ürün Renk



Reflector Angle / Reflektör Açısı

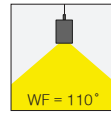

* See page 578 for Idt files. / Işık eğrileri için sayfa 578 bakınız.

Description / Tanım
Aluminium body. Opal or microprismatic diffuser options available. Mains voltage: 220-240V / 50-60Hz. 1-10V, DALI, Casambi DIM, Tunable White DALI, Tunable White CASAMBI, options available. Over 100lm/W efficiency. Emergency kit system can be integrated. Basic colours: white, black, silver, antracite dark gray and special color options available upon request. Steel suspension wire with up to 5mt lenght option together with standart or central baldachine.
Alüminyum gövde. Opal veya mikroprizmatik difüzör seçenekleri mevcuttur. Şebeke gerilimi: 220-240V / 50-60Hz. 1-10V, DALI, Casambi DIM, Dinamik Beyaz DALI, Dinamik Beyaz CASAMBI seçenekleri mevcuttur. 100lm/W üzerinde verimlilik. Acil durum kiti sistemi entegre edilebilir. Temel renkler: beyaz, siyah, gümüş, antrasit koyu gri ve istek üzerine özel renk seçenekleri mevcuttur. Standart veya merkezi baldachine ile birlikte 5mt'ye kadar uzunluk seçeneği ile çelik asma teli.

Product Data / Ürün Bilgileri	
Article Nr. (AVOLUX)	102.LL.14105.(Diameter).(Power).(CRI).(Colour)
Material / Malzeme	Aluminium
Outer Diameter / Dış Çap	75cm
Height / Yükseklik	50mm
Weight / Ağırlık	2.95kg
Mouting method / Montaj yöntemi	Suspendant / Sarkıt

Lighting Technology / Aydınlatma Teknolojisi					
Colour Temperature / Renk Sıcaklığı	2700K	3000K	3500K	4000K	5000K
Luminous flux / Işık akısı	4872lm	5028lm	5106lm	5309lm	5379lm
System efficiency / Sistem verimliliği	97lm/W	101lm/W	102lm/W	106lm/W	108lm/W
Colour rendering / Renk oluşturma	80CRI	80CRI	80CRI	80CRI	80CRI
Beam angle / Işın açısı	110°	110°	110°	110°	110°
Light Output / Işık çıkışı	Only Direct / Sadece Direkt				

Operating technology of the Luminaires / Armatürlerin çalışma teknolojisi	
System Output / Sistem Çıkışı	50W
Voltage Type / Voltaj Tipi	220-240VAC
AC nominal voltage max. / AC nominal voltaj maks.	264VAC
Frequenz max. / Frekans maks.	63Hz
Lamp / Lamba	LED
Protection class / Koruma sınıfı	IP20
Degree of protection / Koruma derecesi	Class I
Control / Kontrol	ON - OFF / DALI / CASAMBI / TUNABLE WHITE
Rated Life time L80/B10 at 25°C	>50000 hrs