

Track System



Track & Track Accessories Ray & Ray Aksesuarları

Track liberates light and luminaires from the constraints of rigid mounting of ceiling base and allows architects to create different designs in inner spaces. Different spotlights with different light character can be installed on track so that different light requirements can be used. Standart Avolux track is operated in 3-circuit installations.

Raylar armatürlerin serbestçe hareket edebilmesini sağlayarak içiğe özgürlük kazandırır. Bu sayede mekanlarınızda daha özgün tasarımlar yaratabilirsiniz. Değişik ışık özelliklerine sahip armatürlerin uygulanabilmesi sayesinde her türlü aydınlatma uygulaması sağlanabilir. Standart Avolux rayları 3-fazlı elektriksel montaj için uygundur.



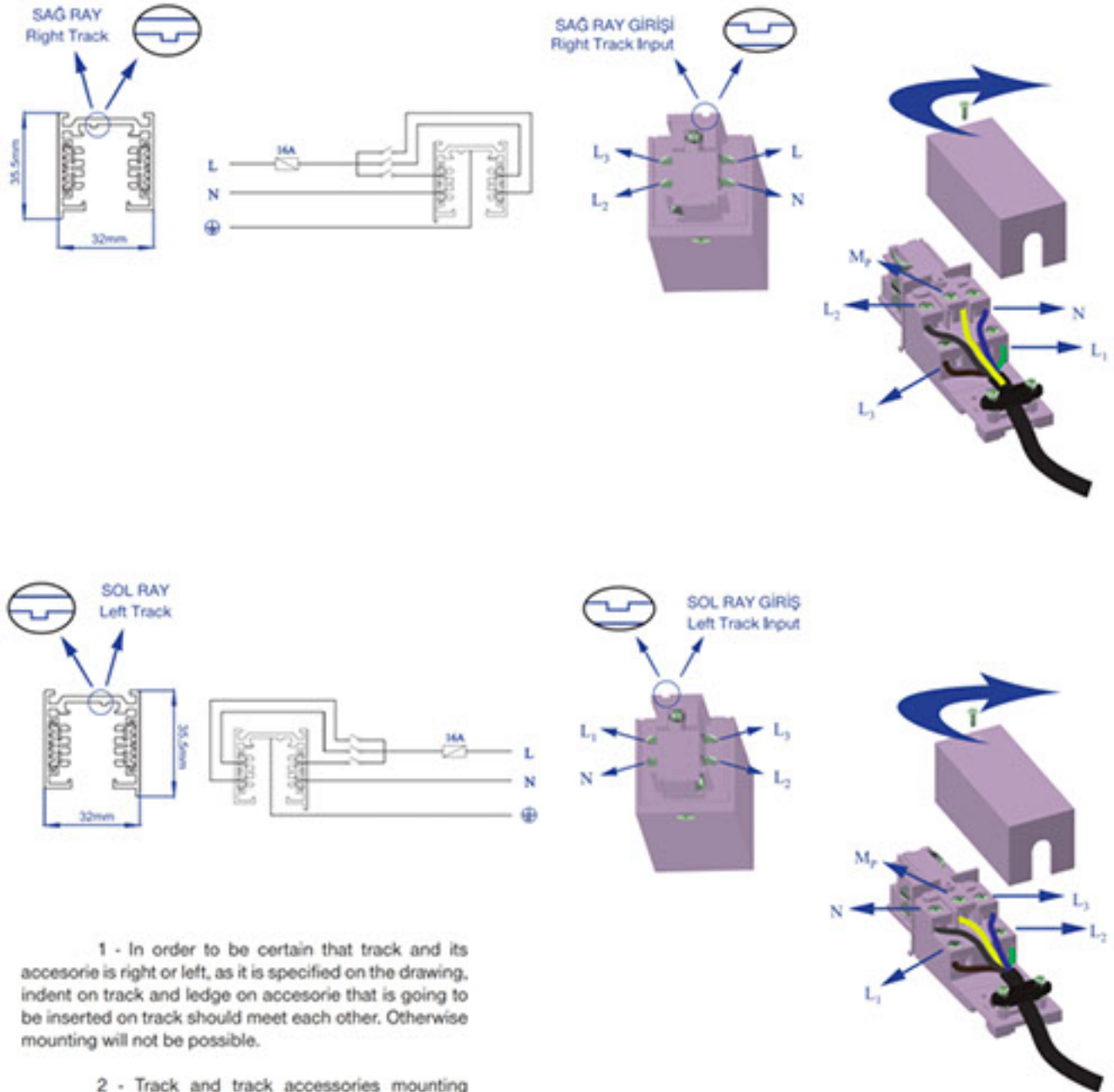

1 - In order to be certain that track and its accesorie is right or left, as it is specified on the drawing, indent on track and ledge on accesorie that is going to be inserted on track should meet each other. Otherwise mounting will not be possible.

2 - Track and track accessories mounting process should be done by skilled electiciens.

1 - Ray ve ray bağlantı parçalarının sağ veya sol olduklarını anlamak için şekildedeki gibi raylarda çıkıntıya, ray bağlantı parçalarında ise girintiye dikkat ediniz.

Montaj esnasında ray ve ray bağlantı parçalarındaki girinti ve çıkıntılar birbirini karşıladığından emin olunuz, aksi takdirde bağlantı parçalarının raya montajını gerçekleştiremezsiniz.

2 - Sağ veya sol ray ve ray giriş parçalarının enerji giriş bağlantı şeması şekildedeki gibidir. Enerji giriş bağlantılarının profesyonel elektrikçiler tarafından yapılması tavsiye edilir.



- Aluminium extruded body.
- IP20 protection class.
- 3-phase circuit system.
- Horizontal copper wire that eliminates the risk of miscontact of adaptor.
- Standart lenght of 1, 2 and 3 meter available. Optionally special lenght can be serviced.
- Pull strength : 100N (10kg)
- Torque max : 2.5 Nm
- Protection class : I
- Rated values : 10A, 250V
- Both surface monting and suspension alternatives available.

- Alüminyum profil gövde.
- IP20 koruma sınıfı.
- 3-Fazlı sistem.
- Ray içerisinde bulunan bakır telin dikey genişliği fazla olması sayesinde adaptörün raya temasızlığı ihtimali ortadan kaldırılmıştır.
- Taşıdığı yük : 100N (10Kg)
- Bükme momenti : 2.5 Nm
- Koruma Sınıfı : I
- Akım gerilimi : 10A, 250V
- Sıvaüstü ve sarkıt montaj seçenekleri mevcuttur.

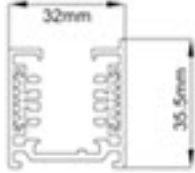

Code / Kod	Lenght / Boy
MK100	1m
MK200	2m
MK300	3m

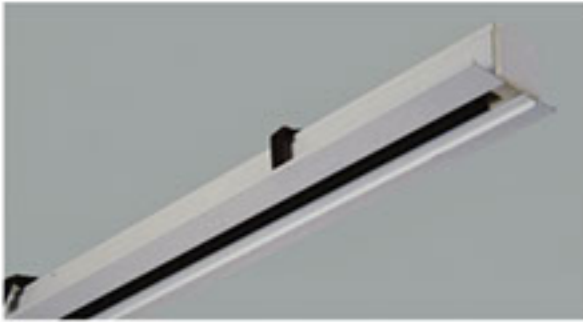
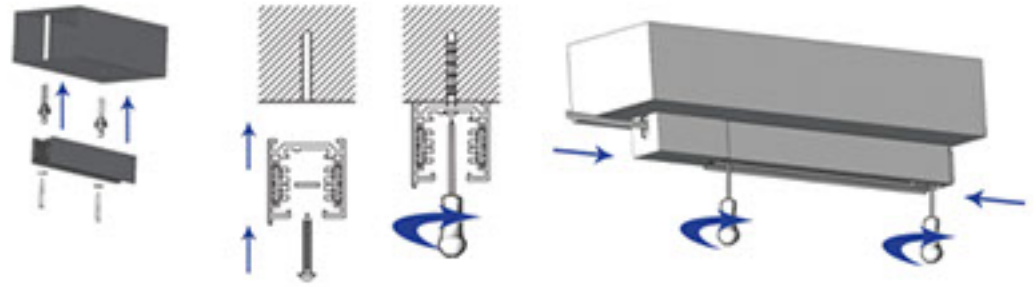

- Aluminium extruded body.
- IP20 protection class.
- 3-phase circuit system.
- Horizontal copper wire that eliminates the risk of miscontact of adaptor.
- Standart lenght of 1, 2 and 3 meter available. Optionally special lenght can be serviced.
- Pull strength : 100N (10kg)
- Torque max : 2.5 Nm
- Protection class : I
- Rated values : 10A, 250V

- Alüminyum profil gövde.
- IP20 koruma sınıfı.
- 3-Fazlı sistem.
- Ray içerisinde bulunan bakır telin dikey genişliği fazla olması sayesinde adaptörün raya temasızlığı ihtimali ortadan kaldırılmıştır.
- Taşıdığı yük : 100N (10Kg)
- Bükme momenti : 2.5 Nm
- Koruma Sınıfı : I
- Akım gerilimi : 10A, 250V

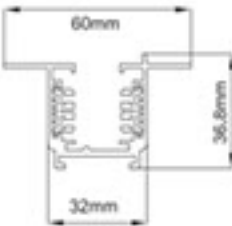

Code / Kod	Lenght / Boy
MR100	1m
MR200	2m
MR300	3m

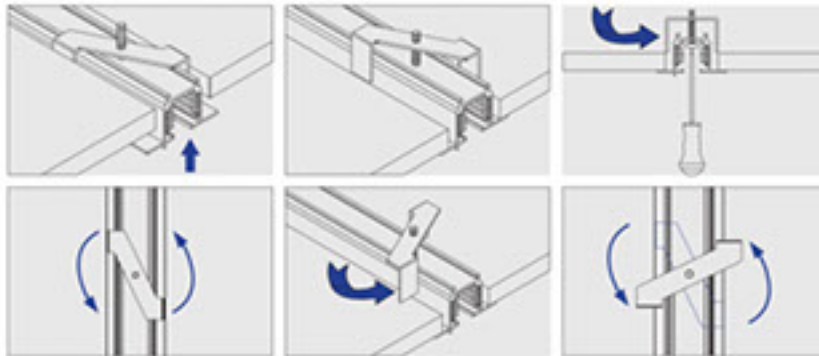

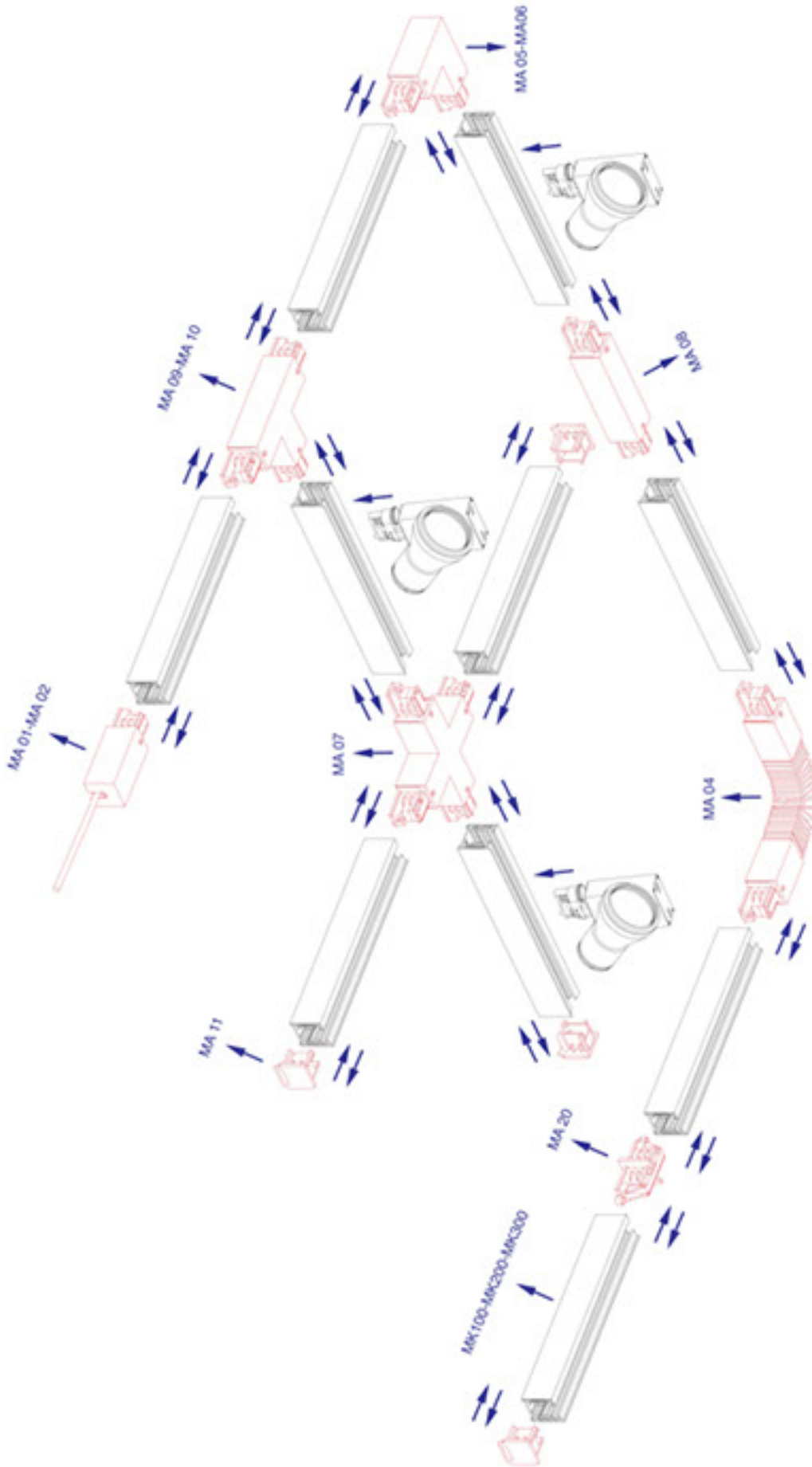



MA 01-Right End / Sağ Bitiş
MA 02-Left End / Sol Bitiş

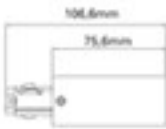

MA 04-Flexible Corner Part
MA 04-Esnek Ara Bağlantı



MA 05-Right L Feed Part
MA 05-Sağ L Bağlantı
MA 06-Left L Feed Part
MA 06-Sol L Bağlantı

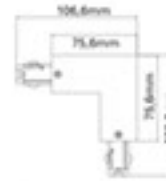

MA 07-X Feed Corner Part
MA 07-X Bağlantı Elemanı

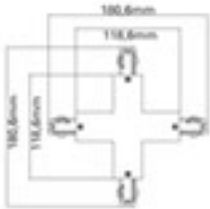

MA 08-Middle Feed Part
MA 08-Ara Bağlantı Elemanı



MA 09-Right T Corner Part
MA 09-Sağ T Köşe Bağlantı
MA 10-Left T Corner Part
MA 10-Sol T Köşe Bağlantı

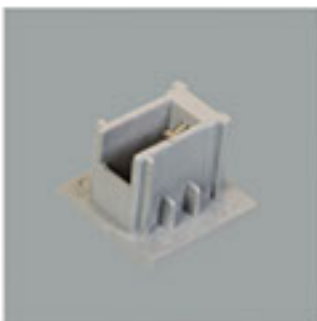
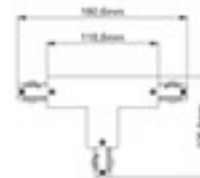

MA 11-End Cap
MA 11-Bitiş Kapağı



MA 20-Middle Extension Part
MA 20-Ray Ara Birleştirme Parçası

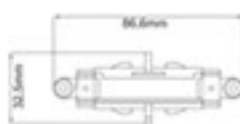

TEL.005 - Steel Suspension Cord
TEL.005 - Ray Sarkıtma Teli

DALI Track System

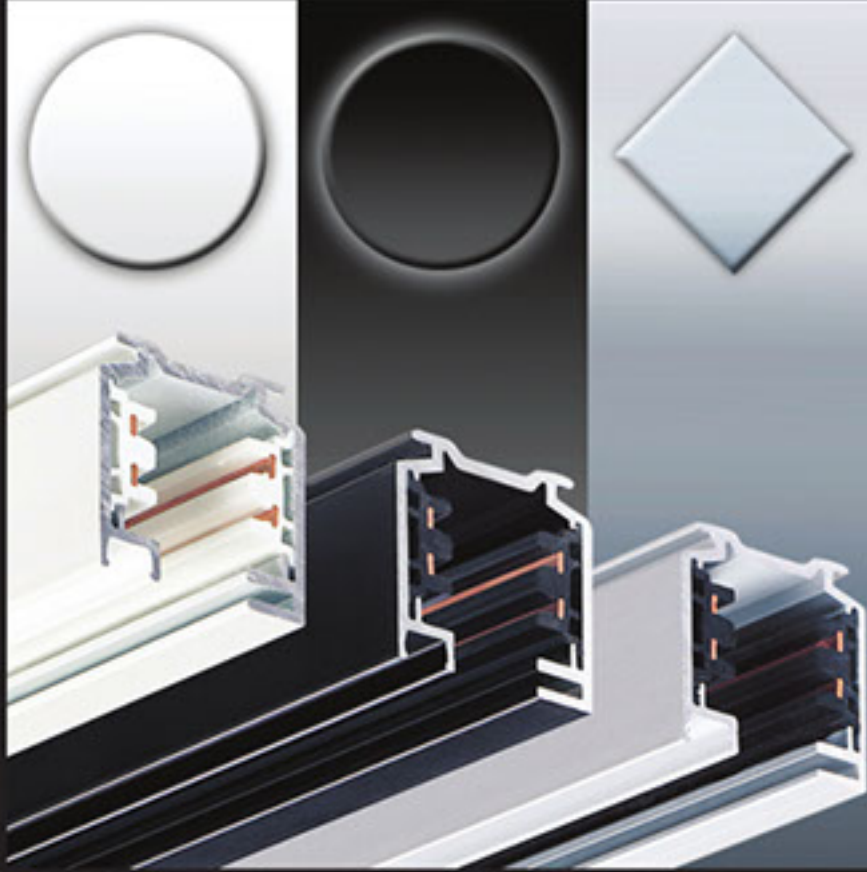

Dali Track Accessories Dali Ray Aksesuarları

Light management system for tracklight applications becoming indispensable for energy efficiency. Avolux uses GLOBAL Dali Track system for its LED tracklights to offer further energy saving.

Ray spot sistemlerinde enerji tasarrufu önemini arttırmaktadır. Avolux GLOBAL Dali ray sistemini kullanarak projelerde LED ray spotların tasarruf oranını arttırmaktadır.

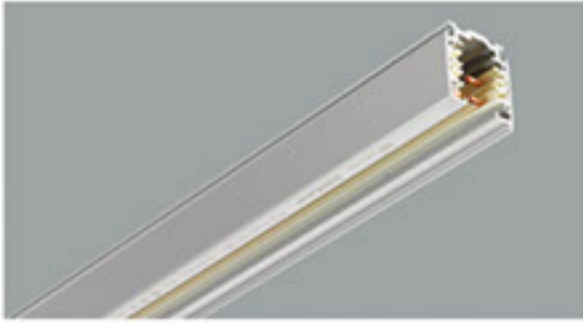

- Aluminium extruded body.
- IP20 protection class.
- Standart light of 1, 2 and 3 meter available. Optionally special length can be serviced.
- Pull strength : 100N (10kg)
- Torque max : 2.5 Nm
- Protection class : I
- Both surface mounting and suspension alternatives available.

- Alüminyum profil gövde.
- IP20 koruma sınıfı.
- Tağıdırı yük : 100N (10Kg)
- Bükme momenti : 2.5 Nm
- Koruma Sınıfı : I
- Sıvaüstü ve sarkıt montaj seçenekleri mevcuttur.

Code / Kod	Length / Boy
MD100	1m
MD200	2m
MD300	3m

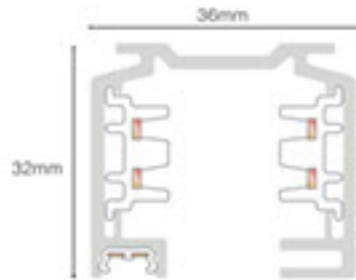

DALI Track Adaptor
Dali Ray Soketi

- Weight : ca. 140 g (.31 lbs)
- Ambient temperature : 0 ... +40°C (32 ... 104°F)
- Ambient humidity : 0-80% non-condensing
- Mounting : on 35mm (1.38 in) DIN rail according to EN 50022
- Outputs : 1xDALI or 1xDMX/RDM (512 channels)
- DALI power supply : I_{max}: 200mA
- Max switching voltage : 30V
- Input voltage : 24VDC / 630mA (± 10%)
- Housing material : PC hardly inflammable
- Protection : IP20
- Certification : CE
- EMC according to : EN55015, EN 61000-3-2

- Ağırlık : ca. 140 g (.31 lbs)
- Ortam sıcaklığı : 0 ... +40°C (32 ... 104°F)
- Ortam nem : 0-80% non-condensing
- Montaj : on 35mm (1.38 in) DIN rail according to EN 50022
- Çıkış : 1xDALI or 1xDMX/RDM (512 channels)
- DALI güç kaynağı : I_{max}: 200mA
- Max switch voltajı : 30V
- Giriş voltajı : 24VDC / 630mA (± 10%)
- Gövde yapısı : PC hardly inflammable
- Koruma sınıfı : IP20
- Sertifika : CE
- EMC : EN55015, EN 61000-3-2

